

Lifeline 4

Description

The Lifeline 4 cable/push button operated system can be installed along or around awkward machinery such as conveyors and provide a constant emergency stop access.

The Lifeline 4 is the only device of its kind to incorporate the following features in one unit making it the most versatile cable switch on the market.

1. The positive mode mechanism helps ensure that the contacts are immediately latched open on actuation and can only be reset by the intentional action of turning the blue reset knob. The design also protects against nuisance tripping and the effects of thermal expansion.
2. A mushroom head emergency stop button is included on the unit to provide E-Stop access even at the extreme ends of the span.
3. The cable status indicator makes the system easy to set up and maintain for spans up to 125 meters.
4. Four sets of contacts are provided: 2 N.C. + 2 N.O. or 3 N.O. + 1 N.O. contacts.
5. Sealed to IP66 with rugged construction using die-cast alloy and stainless steel to withstand harsh conditions.



Features

- Switches up to 125 meter span
- Universal mounting and operation
- Lid mounted emergency stop button, designed to conform to ISO 850
- Switch lockout on cable pulled and cable slack
- Cable status indicator on switch lid

Lid mounted E-Stop button

A mushroom head emergency stop button is included on the unit to provide total E-Stop access even at the extreme ends of the span.



Cable status indicator on lid

The cable status indicator makes the system easy to setup and maintain for spans up to 125 meters.



Specifications

Safety Ratings	
Standards	ISO 13850, EN ISO 12100, IEC 60947-5-1, IEC 60947-5-5
Safety Classification	Cat. 1 device per EN 954-1 May be suitable for use in Cat 3 or Cat 4 systems depending on the architecture and application characteristics
Functional Safety Data * Note: For up-to-date information, visit http://www.ab.com/Safety/	B10d: > 2 x 10 ⁶ operations at min. load PFH _D : < 3 x 10 ⁻⁷ MTTFd: > 385 years May be suitable for use in performance levels Plc or Pld systems (according to ISO 13849-1:2006) and for use in SIL2 or SIL3 systems (according to IEC 62061) depending on the architecture and application characteristics
Certifications	CE Marked for all applicable directives, cULus, TÜV, and CCC

Outputs		
Safety Contacts ‡	2 N.C. direct-opening action	3 N.C. direct-opening action
Auxiliary Contacts	2 N.O. direct-opening action	1 N.O. direct-opening action
Thermal Current I _{th}	10 A	
Rated Insulation Voltage	(Ui) 500V	
Switching Current @ Voltage, Min.	3 mA @ 18V DC	

Utilization Category					
A600/AC-15	(Ue)	600V	500V	240V	120V
	(Ie)	1.2 A	1.4 A	3 A	6 A
DC-13	(Ue)	24V			
	(Ie)	2 A			

Operating Characteristics	
Cable Span Between Switches, Max.	75 m (246 ft) standard model and 75...125 m (146...410 ft) extended length model
Tensioning Force to Run Position	103 N (23.16 lbf) typical
Tensioning Force to Lockout	188 N (42.3 lbf) typical
Operating Force, Min.	<125 N (28.1 lbf) at 300 mm deflection
Actuation Frequency, Max.	1 cycle/s
Mechanical Life	1,000,000 operations

Environmental	
Enclosure Type Rating	IP66
Operating Temperature [C (F)]	-25...80° (-13...176°)

Physical Characteristics	
Housing Material	Heavy-duty painted zinc-based die-cast alloy (LM24)
Indicator Material	Glass-filled nylon
Eye Nut Material	Stainless steel
Weight [g (lb)]	630 (1.38)
Color	Yellow body, blue reset button

* Usable for ISO 13849-1:2006 and IEC 62061. Data is based on the B10d value given and:

- Usage rate of 1op/10 mins., 24 hrs/day, 360 days/year, representing

51840 operations per year

- Mission time/Proof test interval of 38 years

‡ The safety contacts are described as normally closed (N.C.) i.e., with the guard closed, actuator in place (where relevant) and the machine able to be started.

Note: It is recommended that the LRTS (Lifeline Rope Tensioning System) should be used with the Lifeline 4 cable rope switch.

Product Selection

Cable Span	Safety Contacts	Auxiliary Contacts	Cat. No.				
			Conduits		Connectors*		
			M20	1/2 inch NPT	12-Pin M23	8-Pin Micro‡	Connect to ArmorBlock Guard I/O 5-Pin Micro (M12)§
75 m (246 ft)	2 N.C.	2 N.O.	440E-L13137	440E-L13133	440E-L13140	440E-L21BNYH	440E-L2NNNYS
	3 N.C.	1 N.O.	440E-L13042	440E-L13043	440E-L13141	—	—
75...125 m (146...410 ft)	2 N.C.	2 N.O.	440E-L13153	440E-L13155	440E-L13163	440E-L21BTYH	—
	3 N.C.	1 N.O.	440E-L13150	440E-L13152	440E-L13164	—	—

* For connector ratings, see page [Safety Switches and Connectors](#).

‡ For connection to ArmorBlock Guard I/O. With a 5-pin micro (M12) connector, not all contacts are connected. See [Typical Wiring](#) for wiring details.

§ With an 8-pin micro (M12) connector, not all contacts are connected. See [Typical Wiring](#) for wiring details.

Recommended Logic Interfaces

Description	Safety Outputs	Auxiliary Outputs	Terminals	Reset Type	Power Supply	Cat. Page No.	Cat. No.
Single-Function Safety Relays for 2 N.C. Contact Switch							
MSR127RP	3 N.O.	1 N.C.	Removable (Screw)	Monitored Manual	24V AC/DC	MSR127RP/TP	440R-N23135
MSR127TP	3 N.O.	1 N.C.	Removable (Screw)	Auto./Manual	24V AC/DC	MSR127RP/TP	440R-N23132
MSR126T	2 N.O.	None	Fixed	Auto./Manual	24V AC/DC	MSR126R/T	440R-N23117
MSR30RT	2 N.O. Solid State	1 N.O. Solid State	Removable	Auto./Manual or Monitored Manual	24V DC	MSR30RT/RTP	440R-N23198
Modular Safety Relays							
MSR210P Base 2 N.C. only	2 N.O.	1 N.C. and 2 PNP Solid State	Removable	Auto./Manual or Monitored Manual	24V DC from the base unit	MSR210P	440R-H23176
MSR220P Input Module	—	—	Removable	—	24V DC	MSR220P	440R-H23178
MSR310P Base	MSR300 Series Output Modules	3 PNP Solid State	Removable	Auto./Manual Monitored Manual	24V DC	MSR310P	440R-W23219
MSR320P Input Module	—	2 PNP Solid State	Removable	—	24V DC from the base unit	MSR320P	440R-W23218









Note: For additional Safety Relays connectivity, see Safety Relays.
For additional Safety I/O and Safety PLC connectivity, see Programmable Safety Solutions.
For application and wiring diagrams, see Safety Applications and Wiring Diagrams.

Connection Systems



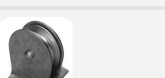



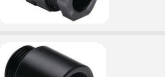
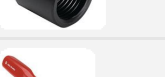

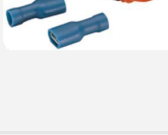

Description	5-Pin Micro (M12)	8-Pin Micro (M12)	12-Pin M23
Cordset	—	889D-F8AB-♣	889M-F12X9AE-♣
Patchcord	889D-F5ACDM-★	889D-F8ABDM-Δ	889M-F12AHMU-◆

- ★ Replace symbol with 0M3 (0.3 m), 1 (1 m), 2 (2 m), 3 (3 m), 5 (5 m), or 10 (10 m) for standard lengths.
- ♣ Replace symbol with 2 (2 m), 5 (5 m), or 10 (10 m) for standard cable lengths.
- Δ Replace symbol with 1 (1 m), 2 (2 m), 3 (3 m), 5 (5 m), or 10 (10 m) for standard cable lengths.
- ◆ Replace symbol with 0M3 (0.3 m), 0M6 (0.6 m), 1 (1 m), 2 (2 m) or 3 (3 m) for standard length.

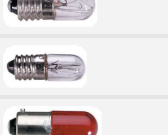
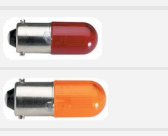
Accessories

Description		Cat. No.
	Lifeline P bolt	440E-A17003
	Lifeline tensioner spring	440E-A13078
	Replacement cover for Lifeline 4 cable/push button	440E-A13054
	Replacement cover for Lifeline 4 cable/push button, no E-Stop	440E-A17115
	Lifeline inside corner pulley	440A-A17101
	Lifeline outside corner pulley	440A-A17102
	Mounting bracket for Lifeline 4 cable/push button	440E-A17130
	Blanking plug, M20 conduit	440A-A07265
	Cable grip, M20 conduit, accommodates cable diameter 7...10.5 mm (0.27...0.41 in.)	440A-A09028
	Adaptor, conduit, M20 to 1/2 inch NPT, plastic	440A-A09042
	Screwdriver including security bit	440A-A09018

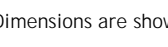
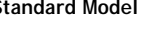
Accessories (continued)

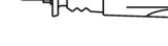
Description	Cat. No.
 Indicator, M20 Conduit Pilot Light—Amber Lens T-3 1/4 Insert Use T-3 1/4 Bulb (Sold Separately)	440A-A19001
 Indicator, 1/2 inch NPT Conduit Pilot Light—Amber Lens T-3 1/4 Insert Use T-3 1/4 Bulb (Sold Separately)	440A-A19005
 Indicator, M20 Conduit Pilot Light—Amber Lens Bayonet Style Insert Use LED Bulb (Sold Separately)	440A-A17124
 Indicator, 1/2in NPT Conduit Pilot Light—Amber Lens Bayonet Style Insert Use LED Bulb (Sold Separately)	440A-A17122
 Indicator, M20 Conduit Pilot Light—Red Lens T-3 1/4 Insert Use T-3 1/4 Bulb (Sold Separately)	440A-A19002
 Indicator, 1/2 inch NPT Conduit Pilot Light—Red Lens T-3 1/4 Insert Use T-3 1/4 Bulb (Sold Separately)	440A-A19007
 Indicator, M20 Conduit Pilot Light—Red Lens Bayonet Style Insert Use LED Bulb (Sold Separately)	440A-A17125
 Indicator, 1/2in NPT Conduit Pilot Light—Red Lens Bayonet Style Insert Use LED Bulb (Sold Separately)	440A-A17123
 Bulb, 24V for Conduit Pilot Light 2.8W T-3 1/4 Bulb, Miniature Screw Base	440A-A09056
 Bulb, 110V for Conduit Pilot Light 2.6W T-3 1/4 Bulb, Miniature Screw Base	440A-A09055
 Bulb, 240V for Conduit Pilot Light 0.75W T-3 1/4 Bulb, Miniature Screw Base	440A-A09054
 Red LED Bulb, 24V AC/DC for Conduit Pilot Light Bayonet Style Insert	800T-N319R
 Amber LED Bulb, 24V AC/DC for Conduit Pilot Light Bayonet Style Insert	800T-N319A
 Red LED Bulb, 120V AC for Conduit Pilot Light Bayonet Style Insert	800T-N320R
 Amber LED Bulb, 120V AC for Conduit Pilot Light Bayonet Style Insert	800T-N320A

Approximate Dimensions

Dimensions are shown in mm (in.). Dimensions are not intended to be used for installation purposes.

Standard Model

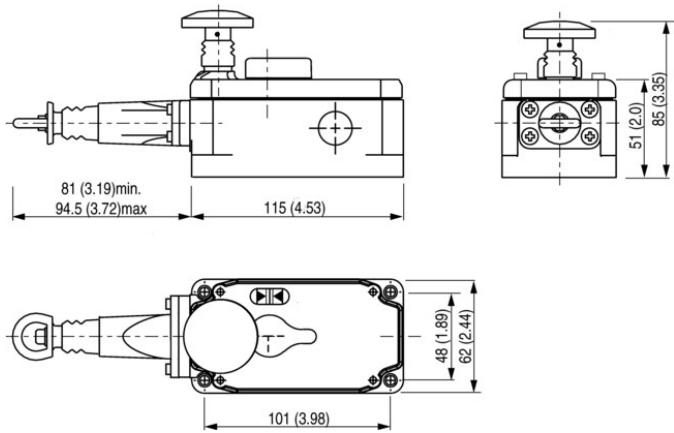

Extended Length Models (75...125 m cable span)

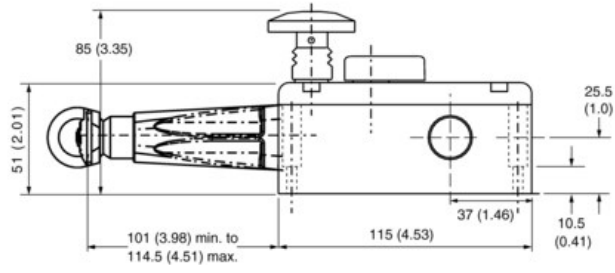
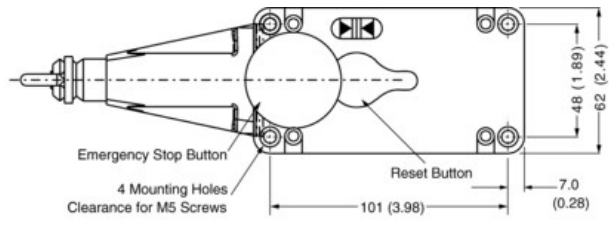
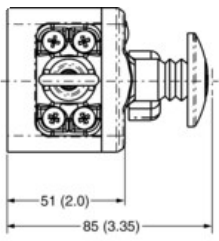

Note: 2D, 3D and electrical drawings are available on www.ab.com.

Typical Wiring Diagrams

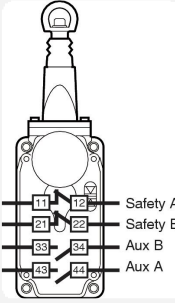
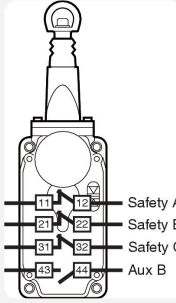
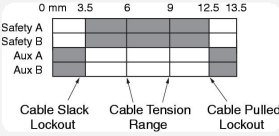
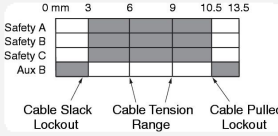
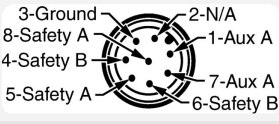
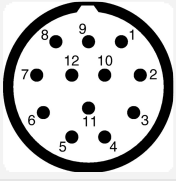
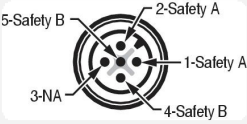
Description		2 N.C. & 2 N.O.	3 N.C. & 1 N.O.
Contact Configuration			
Contact Action			
□ Open ■ Closed			
8-Pin Micro (M12)			—
12-Pin M23	1-3	Safety A	Safety A
	4-6	Safety B	Safety B
	7-8	Aux A	Safety C
	9-10	Aux B	Aux A
Pins 2, 5, 11 not connected	12	Ground	Ground
5-Pin Micro for ArmorBlock Guard I/O			—
8-Pin Cordset 889D-F8AB-*	Grey Red	Safety A	—
	Yellow Pink	Safety B	—
	White Blue	Aux A	—
	Green	Ground	—
	Brown	Not Used	
12-Pin Cordset 889M-F12X9AE-*	Brown Blue	Safety A	Safety A
	White Green	Safety B	Safety B
	Yellow Grey	Aux A	Safety C
	Pink Red	Aux B	Aux A
	Green Yellow	Ground	Ground

* Replace symbol with 2 (2 m), 5 (5 m), or 10 (10 m) for standard cable lengths.

‡ Replace symbol with 0F5 (0.5 ft) or 1F (1 ft) for standard cable lengths.